

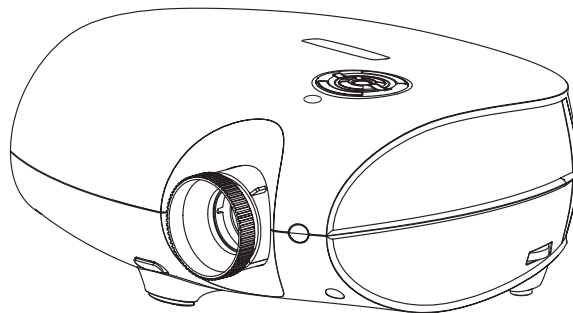

PD4010
PD7010
PD7060
DLP[®] Projector



User's Manual

www.PlanarHomeTheater.com

Planar Systems, Inc.

Corporate Headquarters
1195 NW Compton Drive
Beaverton, OR 97006-1992

Planar Customer Support

Telephone:

US: 1-866-PLANAR1 (866) 752-6271

Outside US: (503) 748-5799

E-mail: PlanarSupport@planar.com

Online Technical Library: <http://www.planar.com/support>

Hours: M-F, 8am - 8pm ET, 12pm - 12am GMT

Copyright

This publication, including all photographs, illustrations and software, is protected under international copyright laws, with all rights reserved. Neither this manual, nor any of the material contained herein, may be reproduced without written consent of the author.

© Copyright October, 2006

Disclaimer

The information in this document is subject to change without notice. The manufacturer makes no representations or warranties with respect to the contents hereof and specifically disclaims any implied warranties of merchantability or fitness for any particular purpose. The manufacturer reserves the right to revise this publication and to make changes from time to time in the content hereof without obligation of the manufacturer to notify any person of such revision or changes.

Trademark Recognition

Kensington is a U.S. registered trademark of ACCO Brand Corporation with issued registrations and pending applications in other countries throughout the world.

All other product names used in this manual are the properties of their respective owners and are acknowledged.

Important Safety Information

Congratulations on purchasing the DLP projector!

Important!

It is strongly recommended that you read this section carefully before using the projector. These safety and usage instructions will ensure that you enjoy many years of safe use of the projector. Keep this manual for future reference.

Symbols Used

Warning symbols are used on the unit and in this manual to alert you of hazardous situations.

The following styles are used in this manual to alert you to important information.



Provides additional information on the topic at hand.

Important!

Provides additional information that should not be overlooked.



Alerts you to situations that may damage the unit.



Alerts you to situations that may damage the unit, create a hazardous environment, or cause personal injury.

Throughout this manual, component parts and items in the OSD menus are denoted in bold font as in this example:

“Push the **Menu** button on the remote control to open the **Main** menu.”

General Safety Information

- Do not open the unit case. Aside from the projection lamp, there are no user-serviceable parts in the unit. For servicing, contact qualified service technician.
- Follow all warnings and cautions in this manual and on the unit case.
- The projection lamp is extremely bright by design. To avoid damage to eyes, do not look into the lens when the lamp is on.
- Do not place the unit on an unstable surface, cart, or stand.
- Avoid using the system near water, in direct sunlight, or near a heating device.
- Do not place heavy objects such as books or bags on the unit.

Power Safety

- Only use the supplied power cord.
- Do not place anything on the power cord. Place the power cord where it will not be in the way of foot traffic.
- Remove the batteries from the remote control when storing or not in use for a prolonged period.

Replacing the Lamp

Replacing the lamp can be hazardous if done incorrectly. Refer to “Replacing the Projection Lamp” on page 31 for clear and safe instructions for this procedure. Before replacing the lamp:

- Unplug the power cord.
- Allow the lamp to cool for about one hour.

Important Recycle Instructions:



Lamp(s) inside this product contain mercury. This product may contain other electronic waste that can be hazardous if not disposed of properly. Recycle or dispose in accordance with local, state, or federal Laws. For more information, contact the Electronic Industries Alliance at WWW.EIAE.ORG. For lamp specific disposal information check WWW.LAMPRECYCLE.ORG. Disposal of old Electrical & Electronic Equipment (Applicable throughout the European Union and other European countries with separate collection programs)



This symbol found on your product or on its packaging, indicates that this product should not be treated as household waste when you wish to dispose of it. Instead, it should be handed over to an applicable collection point for the recycling of electrical and electronic equipment. By ensuring this product is disposed of correctly, you will help prevent potential negative consequences to the environment and human health, which could otherwise be caused by inappropriate disposal of this product. The recycling of materials will help to conserve natural resources. This symbol is only valid in the European Union. If you wish to discard this product, please contact your local authorities or dealer and ask for the correct method of disposal.

Cleaning the Projector

- Unplug the power cord before cleaning. Refer to “Cleaning the Projector” on page 33.
- Allow the lamp to cool for about one hour.

Regulatory Warnings

Before installing and using the projector, read the regulatory notices in the “Regulatory Compliance” section on page 45.

Main Features

- Theater image right at home
- Compatible with all major video standards including NTSC, PAL, and SECAM
- High definition resolution (1280 x 720 for PD7010 and PD7060 only), and 16:9 wide-screen resolution from any HD source.
- Supports resolutions up to WXGA at 16.7 million colors to deliver crisp, clear images
- Flexible setup allows for front and rear projections
- Line-of-vision projections remain square, with advanced keystone correction for angled projections
- Input source can be set for automatic detection

About This Manual

This manual is intended for end users and describes how to install and operate the DLP projector. Wherever possible, relevant information—such as an illustration and its description—has been kept on one page. This printer-friendly format is both for your convenience and to help save paper, thereby protecting the environment. It is suggested that you only print sections that are relevant to your needs.

Register Your Planar Product Today

Thank you for choosing Planar. To assure you receive all the benefits of your Planar product and services, register your Planar product today. Visit our web site:

http://www.planar.com/support/product_registration.html

Cables, Replacement Lamps and Accessories

To find cables, replacement lamps and accessories for your Planar projector, LCD monitor, touchscreen, or other Planar products, visit our online store: <http://www.PlanarOnline.com> or find other stores that stock Planar products at <http://www.planar.com/howtobuy>.

Table of Contents

GETTING STARTED

Packing Checklist.....	7
A Tour of the Projector	8
Remote Control Functions	12
Remote Control Operating Range	13
Projector and Remote Control Buttons.....	13

SETUP AND OPERATION

Inserting the Remote Control Batteries	14
Connecting Input Devices	15
Starting and Shutting down the Projector	16
Adjusting the Projector Level	17
Adjusting the Focus and Zoom.....	18

ON-SCREEN DISPLAY (OSD) MENU SETTINGS

OSD Menu Controls	19
Setting the OSD Language	20
OSD Menu Overview	21
Image Menu	22
Display Menu	25
Advanced Menu	27
Language Menu	28
User Color Menu	29
Service Menu	30

MAINTENANCE AND SECURITY

Replacing the Projection Lamp.....	31
Resetting the Lamp	33
Cleaning the Projector	33
Using the Kensington® Lock	34

TROUBLESHOOTING

Tips for Troubleshooting	35
LED Error Messages	36
Common Problems and Solutions.....	37

SPECIFICATIONS

Hardware Specifications.....	39
Input/output Connectors	40

TIMING MODE TABLE

Projector Dimensions	44
----------------------------	----

REGULATORY COMPLIANCE

FCC Warning.....	45
Canada	45
Safety Certifications.....	45
EN 55022 Warning	45

GETTING STARTED

Packing Checklist

Carefully unpack the projector and check that the following items are included.



DLP Projector



**Remote Control
(with two AAA batteries)**



**DVI to HDMI Adaptor
(PD4010 only)**

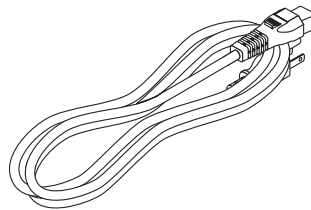

**Power Cord
(By country)**

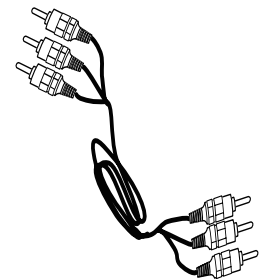

**Component Video
Cable**

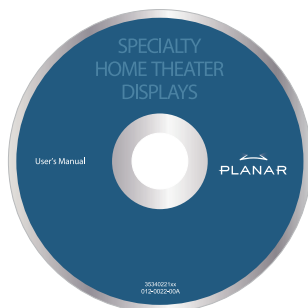

**CD-ROM
(This User's Manual)**

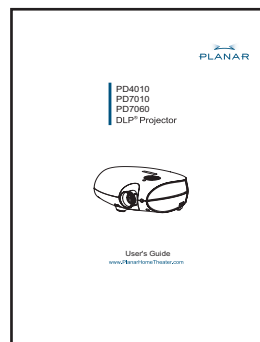

User's Guide

Contact your dealer immediately if any items are missing, appear damaged, or if the unit does not work.

A Tour of the Projector

Front-right View



ITEM	LABEL	DESCRIPTION
1	Control panel	Operates the onscreen display. Refer to the next page for a description of the buttons
2	Lens zoom	Enlarges the projected image
3	Focus	Focuses the projected image
4	Lens	Remove Lens Cover before use
5	Front IR receiver	Receiver for IR signal from remote control
6	Lens cover	Attach the lens cover to protect lens when not in use

Important!

Ventilation openings on the projector allow for good air circulation, which keeps the projector lamp cool. Do not obstruct any of the ventilation openings.

On-screen Display (OSD) Buttons



ITEM	LABEL	DESCRIPTION
1	Power	Turns the projector on or off
2	Source	Detects the input device
3	Up cursor	Navigates and changes settings in the OSD
4	Left cursor	Navigates and changes settings in the OSD
5	Enter	Changes settings in the OSD
6	Right cursor	Navigates and changes settings in the OSD
7	Down cursor	Navigates and changes settings in the OSD
8	Menu	Opens and exits the OSD

Rear Ports

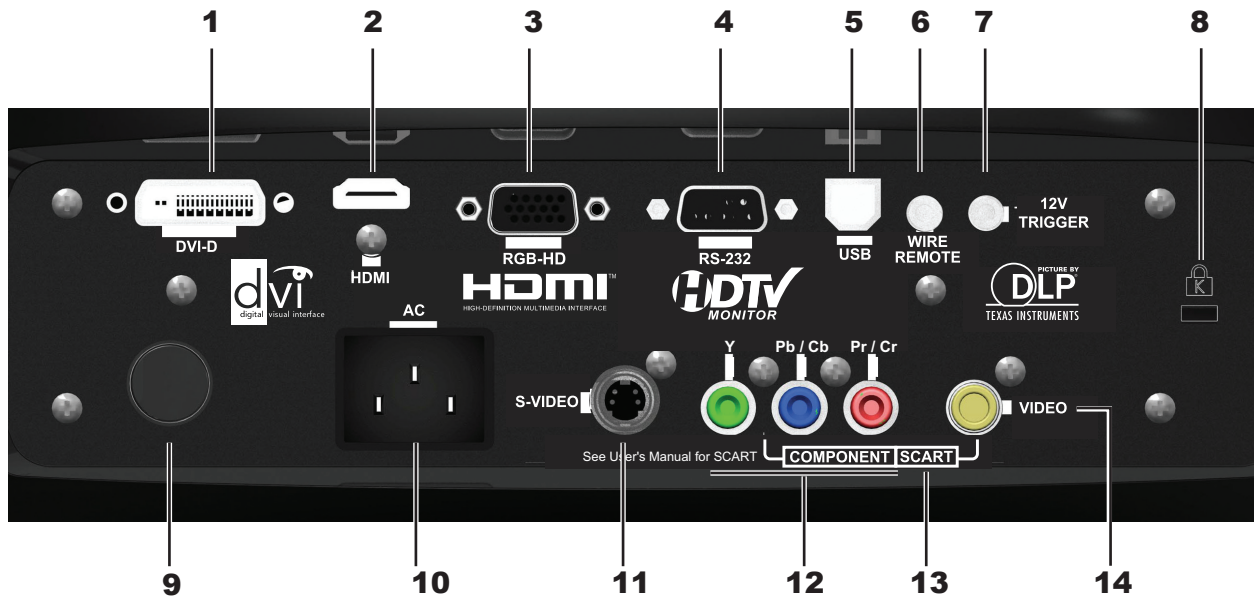

ITEM	LABEL	DESCRIPTION
1	DVI-D	Connect the computer cable from a computer or video source
2	HDMI	Connect a High-Definition Multimedia Interface cable from home theater and consumer electronics equipment (Only in models PD7010 and PD7060)
3	RGB HD in	Connect a VGA cable (not supplied) from a computer
4	RS-232	Installation control
5	USB	Connect the USB cable (not supplied) from a computer
6	Wired remote	Connect a wired remote control device
7	Trigger 12V	3.5mm mini-jack trigger provides a 12 volt, 0.25 amp DC output
8	Security lock	Secure to permanent object with a Kensington® Lock system
9	Rear IR receiver	Receiver for IR signal from remote control
10	Power	Connect the supplied power cord
11	S-Video	Connect S-Video cable (not supplied) from a video device to the S-Video jack
12	Component	Connect component video cables from a video device to the Y, Pb/Cb, and Pr/Cr RCA jacks
13	SCART	Connect SCART video cables (SCART to the Y, Pb/Cb, Pr/Cr and yellow Video-In jack, not supplied) from a video device
14	Video-in	Connect a composite video cable (not supplied) from a video device to the yellow RCA jack

Bottom View



ITEM	LABEL	DESCRIPTION
1	Ceiling support holes	Contact your dealer for information on mounting the projector on a ceiling
2	Tilt adjuster	Adjust angle of the picture
3	Height adjuster button	Push to release height adjuster
4	Height adjuster	Adjuster drops down when adjuster button is pushed

Remote Control Functions

ITEM	LABEL	DESCRIPTION
1	Power on	Turns projector power on
2	Power off	Turns projector power off
3	Source 1	User configurable (Default: HDMI)
4	Source 2	User configurable (Default: Component)
5	Source 3	User configurable (Default: DVI-D)
6	Source 4	User configurable (Default: PC)
7	Source 5	User configurable (Default: Video/S-Video)
8	Up cursor	Navigates and changes settings in the OSD
9	Left cursor	
10	Enter	Changes settings in the OSD
11	Right cursor	Navigates and changes settings in the OSD
12	Down cursor	
13	Menu	Opens the OSD
14	Exit	Exits OSD menus or menu selection fields
15	Hot key 1	User memory setting 1
16	Hot key 2	User memory setting 2
17	Hot key 3	User memory setting 3
18	Contrast	Adjusts screen contrast
19	Brightness	Adjusts screen brightness
20	Aspect ratio	Toggles aspect ratio: 16:9 → Letterbox → 4:3 → Native
21	Gamma	Toggles gamma: Film → Video → Cinema → PC → Photo
22	Overscan	Toggles overscan: Off → Crop → Zoom
23	Keystone	Adjusts keystone
24	Auto	Automatically synchronizes display settings in RGB mode
25	Blank	Makes the screen blank
26	LED	Turns back LED light on and off



Remote Control Operating Range

The remote control uses infrared transmission to control the projector. It is not necessary to point the remote directly at the projector. Provided you are not holding the remote control perpendicular to the sides, the remote control functions within a radius of about 10 meters (33 feet) and 30 degrees above or below the projector level. If the projector does not respond to the remote control, move a little closer.

Important!

1. *Avoid using the remote control with bright fluorescent lighting turned on. Certain high-frequency fluorescent lights can disrupt remote control operation.*
2. *Be sure nothing obstructs the path between the remote control and the projector. If the path between the remote control and the projector is obstructed, you can bounce the signal off certain reflective surfaces such as projector screens.*
3. *The buttons and keys on the projector have the same functions as the corresponding buttons on the remote control. This user's manual describes the functions based on the remote control.*

Projector and Remote Control Buttons

The projector can be operated using the remote control or the buttons on the top of the projector. All operations can be carried out with the remote control; however the buttons on the projector are limited in use. The following illustration shows the corresponding buttons on the remote control and on the projector.

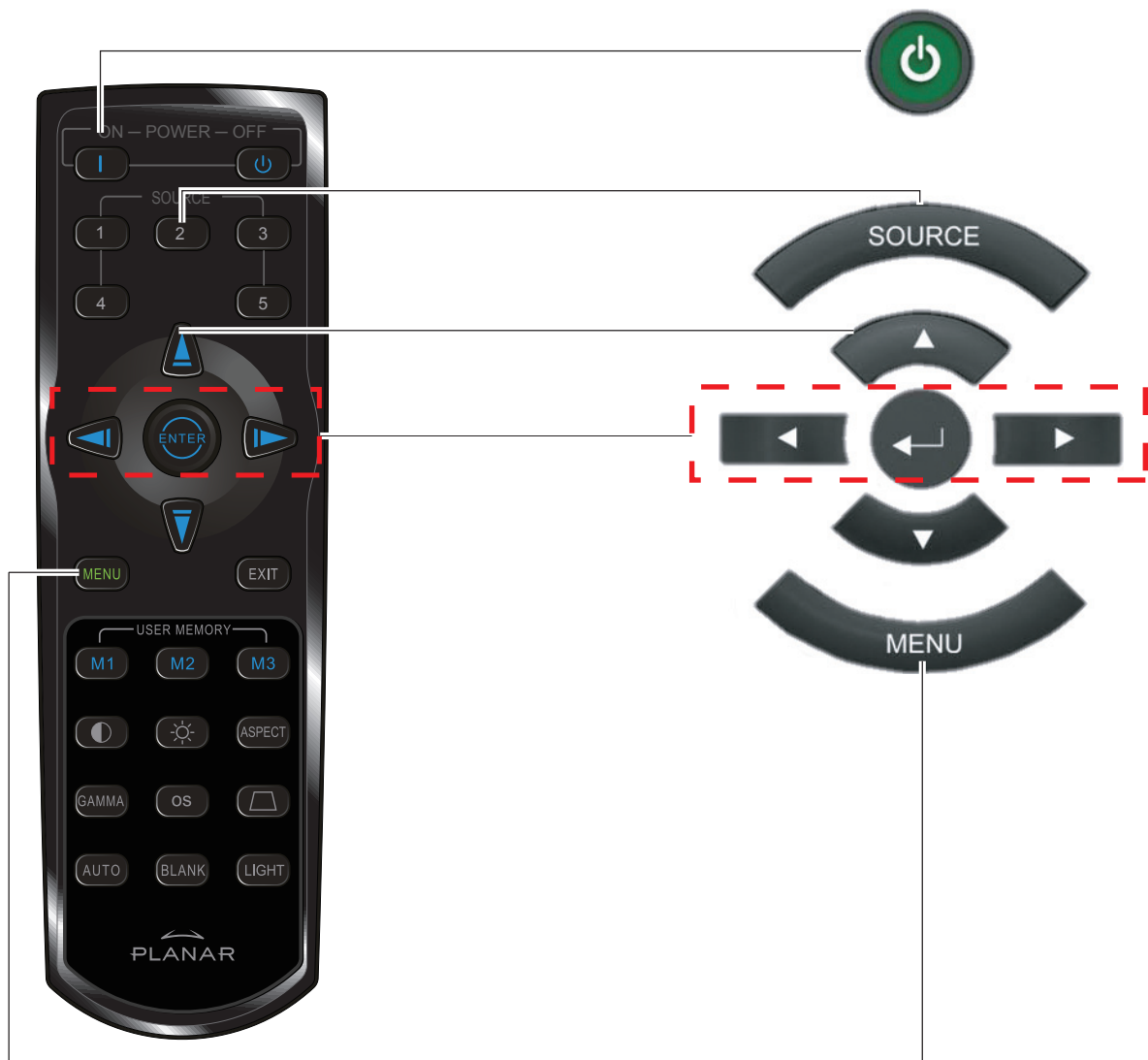

SETUP AND OPERATION

Inserting the Remote Control Batteries

1. Remove the battery compartment cover by sliding the cover in the direction of the arrow.

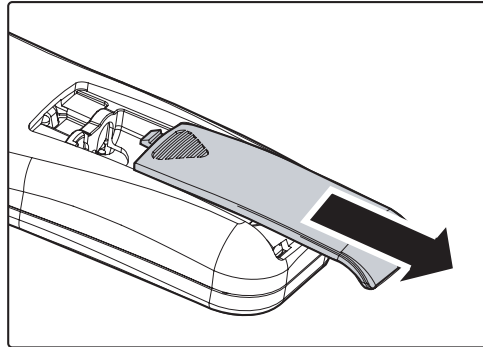

2. Insert the supplied batteries taking note of the polarity (+/-) as shown here.

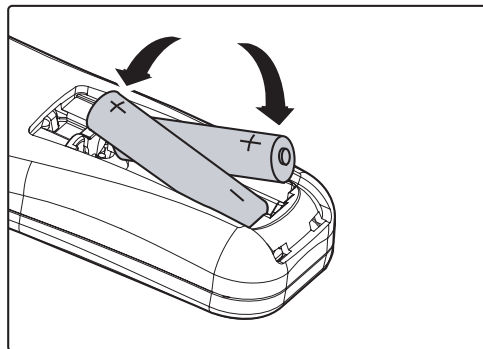

3. Replace the cover.

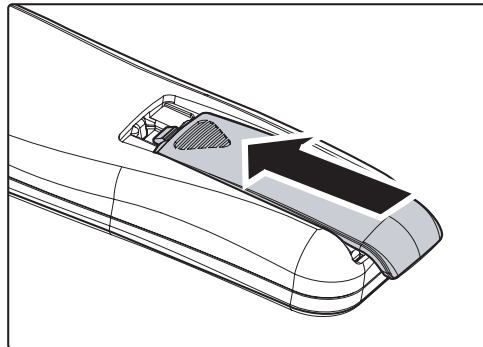

1. *Only use AAA alkaline batteries.*
2. *Dispose used batteries according to local ordinance regulations.*
3. *Remove the batteries when not using the projector for prolonged periods.*

Connecting Input Devices

A PC or notebook computer as well as video devices can be connected to the projector at the same time. Video devices include DVD, VCD, and VHS players, as well as movie camcorders, digital still cameras and high definition sources. Check the user manual of the connecting device to confirm it has the appropriate output connector.



WARNING

As a safety precaution, disconnect all power to the projector and connecting devices before making connections.

Starting and Shutting down the Projector

1. Remove the lens cover.
2. Connect the power cord to the projector. Connect the other end to a wall outlet.
3. Press the **Power** button. The Power LED on the projector turns on. Turn on the connected devices.
4. The language selection screen appears (Initial setup only). Select the desired language.
 1. Press the cursor ▲▼ button until **Language** is highlighted.
 2. Press the cursor ◀▶ or **Menu** button to confirm the language, and close the OSD.

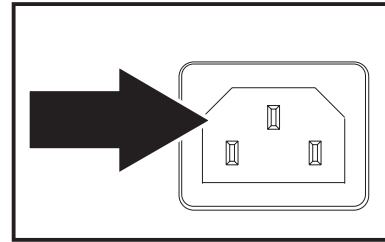

5. If more than one input device is connected, press the source button to search.
6. Press the **Power** button to turn off the projector. The Powering Down screen appears.

Note: Pressing the Power button again within five (5) seconds cancels powering down the projector.
7. When the **Power** LED stops flashing, the projector goes on standby mode.



Do not unplug the power cord until the Power LED stops flashing, indicating the projector has cooled down.

Adjusting the Projector Level

Take note of the following when setting up the projector:

- The projector table or stand should be level and sturdy.
- Position the projector so that it is perpendicular to the screen.
- Be sure cables are not in the way or can cause the projector to be knocked over.

- 1.** To raise the level of the projector, lift the projector and press the height-adjuster button **[A]**.

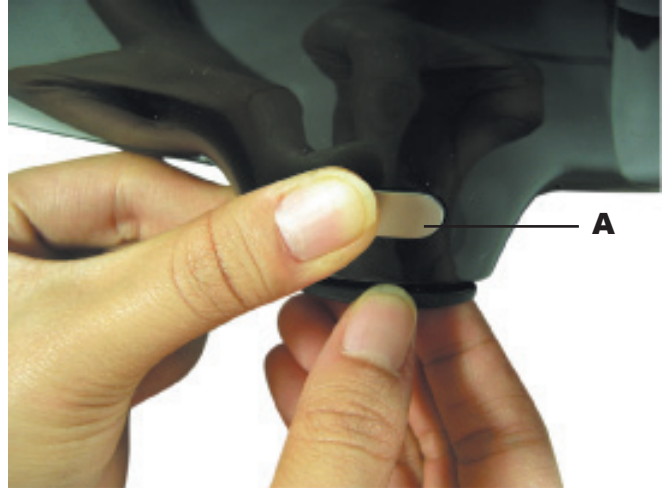

The height adjuster drops down **[B]**.

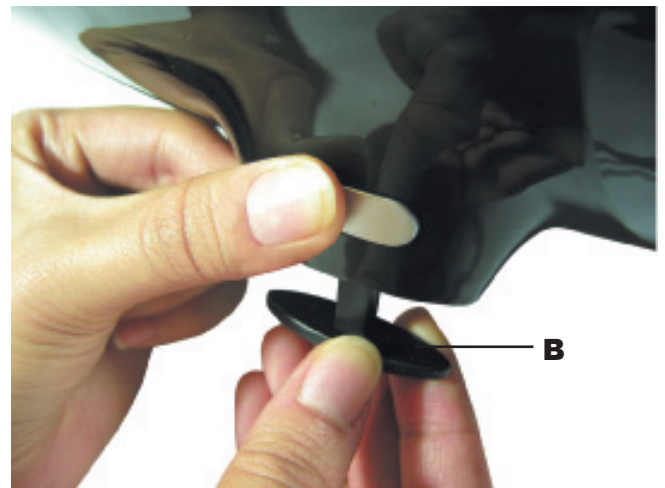

- 2.** To lower the level of the projector, press the height-adjuster button and push down on the top of the projector.
- 3.** To adjust the angle of the picture, turn the tilt adjuster right or left until the desired angle has been achieved.



Adjusting the Focus and Zoom

1. Locate the image zoom and focus adjustment rings on the projector.



2. Use the image zoom control to resize the projected image and screen size.



3. Rotate the image focus control to sharpen the projected image.



ON-SCREEN DISPLAY (OSD) MENU SETTINGS

OSD Menu Controls

The projector has an OSD that lets you make image adjustments and change various settings. When the projector is turned on, any connected devices are detected. If the connected device is a PC, press the appropriate keys on the computer keyboard to switch the display output to the projector. (Check the user manual of the PC to determine the appropriate Fn key combination to change display output.)

Navigating the OSD

You can use the remote control cursor buttons or the buttons on the top of the projector to navigate and make changes to the OSD. The following illustration shows the corresponding buttons on the remote control and on the projector.

1. To open the OSD, press the **Menu** button.
2. There are six menus. Press the cursor ◀ ▶ button to move through the menus.
3. Press the cursor ▲ ▼ button to move up and down in a menu.
4. Press ◀ ▶ to change values for settings, and then press **Enter** to confirm the new setting.
5. Press **Menu** to close the OSD or leave a submenu.

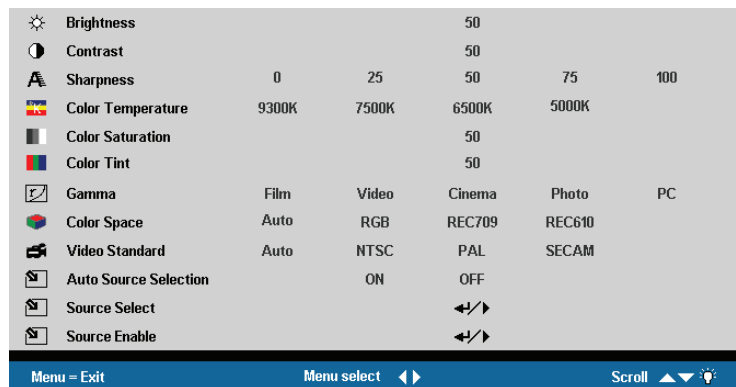

☀	Brightness					50
🌑	Contrast					50
🔍	Sharpness	0	25	50	75	100
🇺🇸	Color Temperature	9300K	7500K	6500K	5000K	
■	Color Saturation			50		
🌈	Color Tint			50		
📄	Gamma	Film	Video	Cinema	Photo	PC
🌐	Color Space	Auto	RGB	REC709	REC610	
📺	Video Standard	Auto	NTSC	PAL	SECAM	
📺	Auto Source Selection		ON	OFF		
📺	Source Select			◀/▶		
📺	Source Enable			◀/▶		

Menu = Exit Menu select ◀▶ Scroll ▲▼



Depending on the video source not all items in the OSD are available. For example, the Horizontal/Vertical Position items in the Setup menu can only be modified when connected to a PC. Items that are not available cannot be accessed and are grayed out.

Setting the OSD Language

You may want to reference the OSD on your projector while reading this section. Set the OSD language to your preference before continuing. (The default language is English.)

1. Press the **Menu** button. The **Image** menu appears.

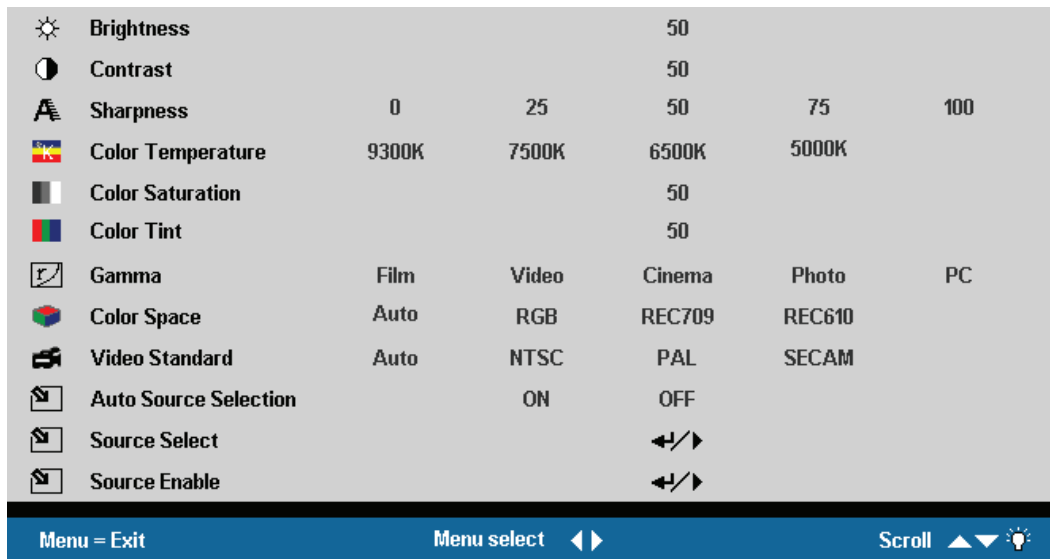

2. Press the cursor ◀ ▶ button until **Language** is highlighted.

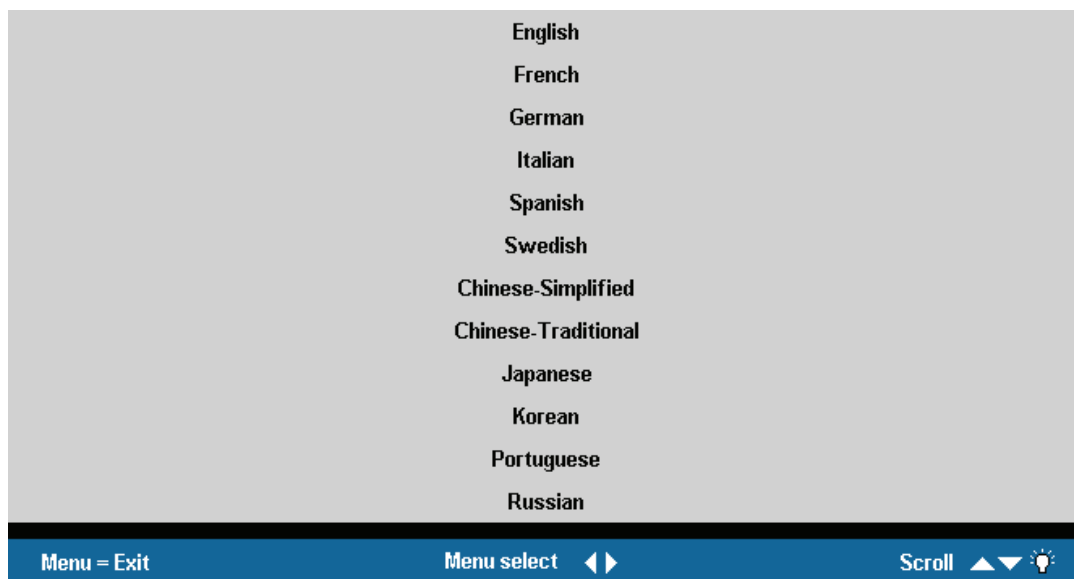

3. Press the cursor ▲ ▼ button until the desired **Language** is highlighted.
4. Press the **Menu** button to confirm the language, and close the OSD.

OSD Menu Overview

Use the following illustration to quickly find a setting or determine the range for a setting.

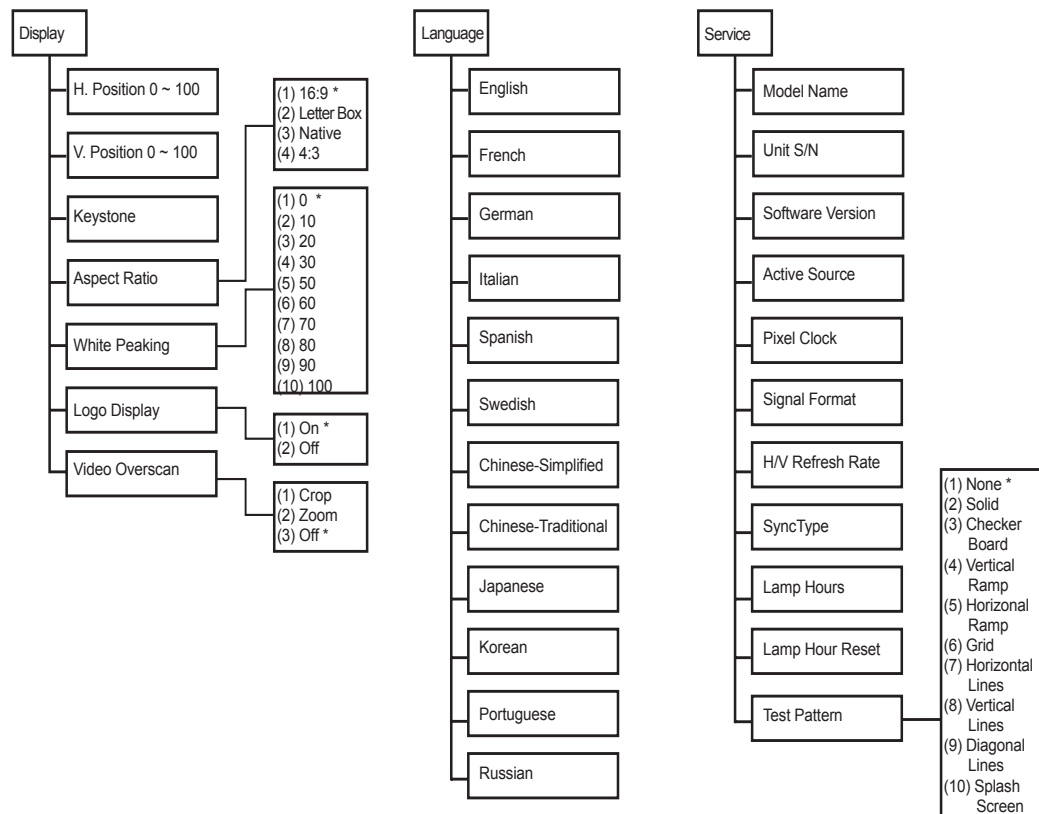
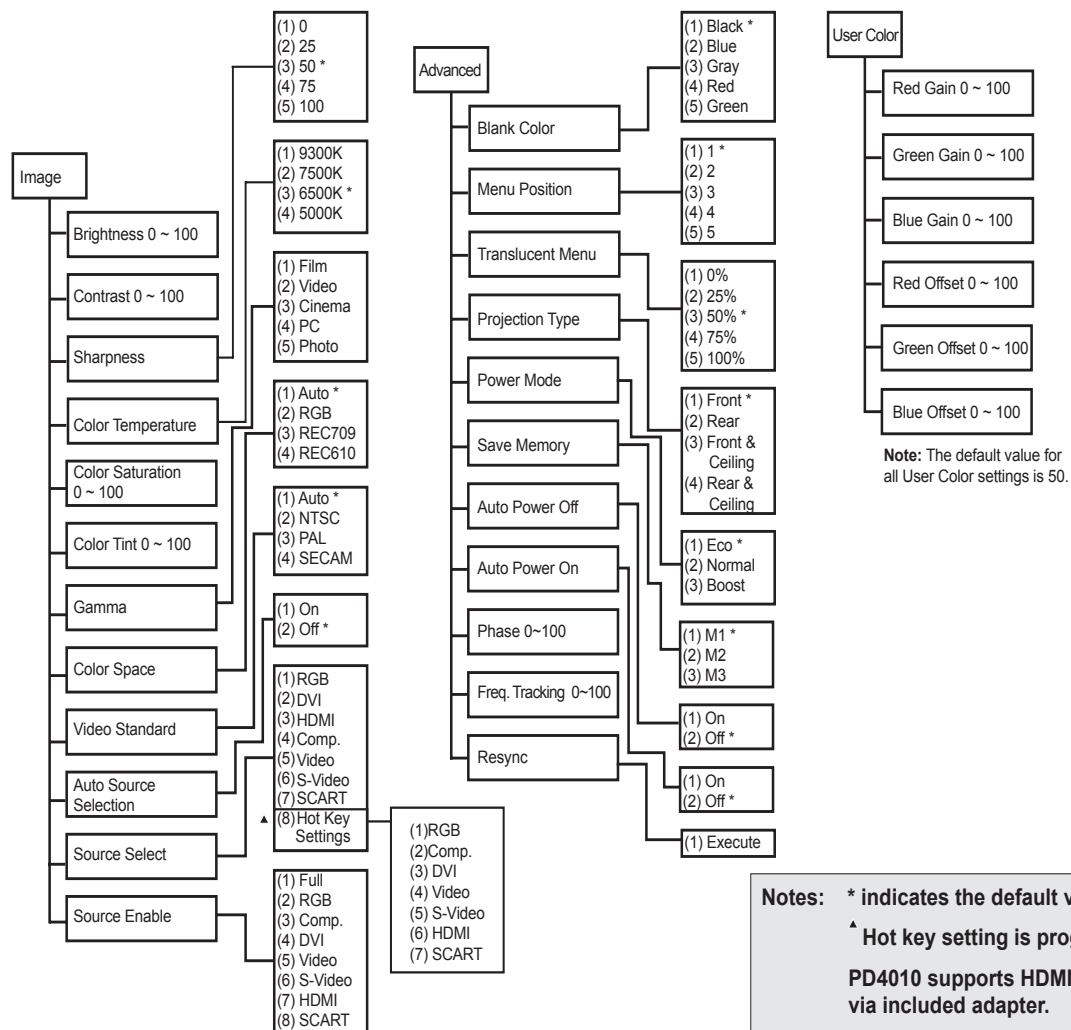
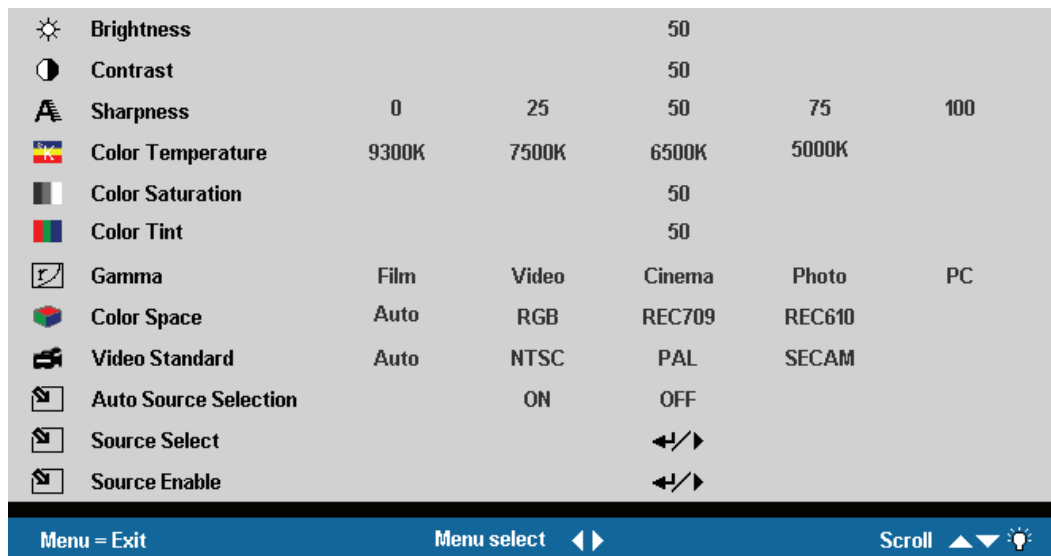
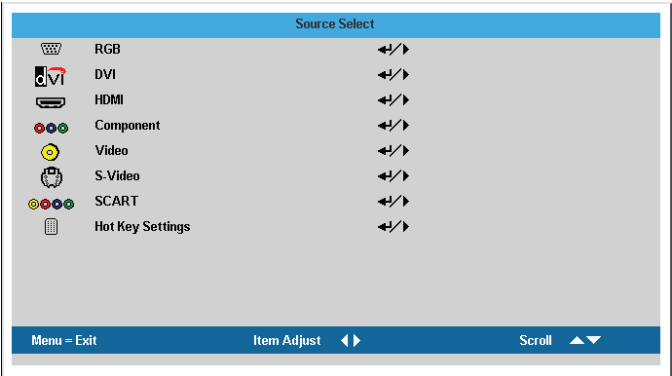

Image Menu

Press the **Menu** button to open the **OSD** menu. Press the cursor ◀ ▶ button to move to the **Image** menu. Press the cursor ▲ ▼ button to move up and down in the **Image** menu. Press ◀ ▶ to change values for settings, and then press **Enter** to confirm the new setting.



ITEM	DESCRIPTION	DEFAULT
Brightness	Press the cursor ◀ ▶ button to adjust the brightness. (Range: 0 – 100)	50
Contrast	Press the cursor ◀ ▶ button to adjust the contrast. (Range: 0 – 100)	50
Sharpness	Press the cursor ◀ ▶ button to adjust the display sharpness (Range: 0-100)	50
Color temperature	Press the cursor ◀ ▶ button to adjust the video tint/hue. (Options: 9300K – 7500K – 6500K – 5000K)	6500K
Color saturation	Press the cursor ◀ ▶ button to adjust the video saturation. (Range: 0 – 100) Note: Color saturation is available for Video and S-Video modes only.	50
Color tint	Press the cursor ◀ ▶ button to adjust the video tint/hue. (Range: 0 – 100) Note: Color tint is available for Video and S-Video modes only.	50
Gamma	Press the cursor ◀ ▶ button to adjust the gamma correction of the display. (Options: Film, Video, Cinema, Photo, PC)	PC [VGA] Video [DVI, HDMI, Component, Video, S-Video, and SCART]
Color space	Press the cursor ◀ ▶ button to adjust the color space. (Options: Auto – RGB – YPbPr- YCbCr) Note: Color space is available for component, PC, HDMI, and DVI modes only.	Auto
Video standard	Press the cursor ◀ ▶ button to adjust the Video Standard. (Options: Auto, NTSC, PAL, SECAM) Note: Video standard is available for Video and S-Video modes only.	Auto

ITEM	DESCRIPTION	DEFAULT
Auto source selection	Press the cursor ◀ ▶ button to enable auto source selection.	OFF
Source select	<p>Press the cursor button ◀ ▶ to manually select the source. The following screen appears.</p>  <p>Press the cursor button ▲ ▼ to move up and down the menu. Press the cursor button to select an input source:</p> <p>RGB: select RGB input to display images from a computer.</p> <p>DVI: select Digital Video Input for digital display quality.</p> <p>HDMI: select High-Definition Multimedia Interface. HDMI is a digital, point-to-point interface for video signals designed as a single-cable solution for home theater and consumer electronics equipment.</p> <p>Component: select component video as the input source. Component video maintains the three YUV video signals in three separate channels and provides a sharper image than composite video and S-Video.</p> <p>Video: select composite video as the input source. Composite video combines all three YUV video signals into one channel. NTSC, PAL and SECAM television are examples of composite video sources. S-Video and component video provide a sharper image than composite video.</p> <p>S-Video: select Super Video as the input source. S-Video combines the three YUV video signals into two channels. S-Video provides a sharper image than composite video, but is not as good as component video.</p> <p>SCART: SCART connectors are prevalent in Europe. SCARTs are used to hook up VCRs and DVD players to TV sets.</p> <p>Hot Key Settings: Press the cursor button to set hot keys.</p>	—
Source enable	Press Enter to enable selection of the source (Auto source selection must be enabled).	Full

OSD menu Functions Available for Connected Source

FUNCTION	RGB	DVI	HDMI	COMPONENT VIDEO	COMPOSITE VIDEO	S-VIDEO	SCART
Brightness	x	x	x	x	x	x	x
Contrast	x	x	x	x	x	x	x
Sharpness	x	x	x	x	x	x	x
Color Temp	x	x	x	x	x	x	x
Color Saturation				x	x	x	
Color Tint				x	x	x	
Gamma	x	x	x	x	x	x	x
Color Space	x	x	x	x			
Video Standard					x	x	

x = available to video source

Display Menu

Press the **Menu** button to open the **OSD** menu. Press the cursor ◀ ▶ button to move to the **Display** menu. Press the cursor ▲ ▼ button to move up and down in the **Display** menu. Press ◀ ▶ to change values for settings, and then press **Enter** to confirm the new setting.

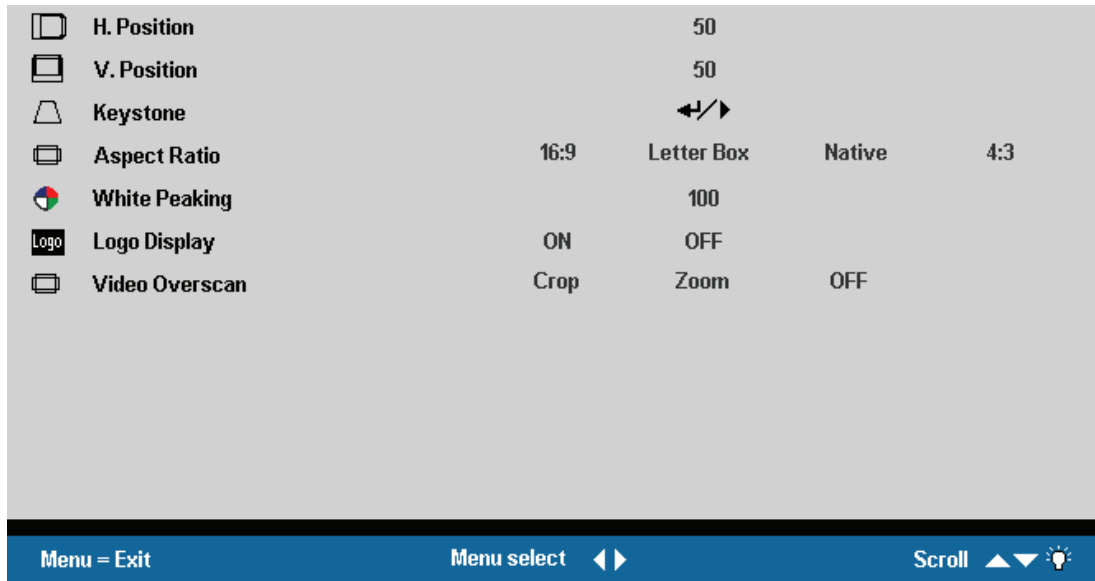

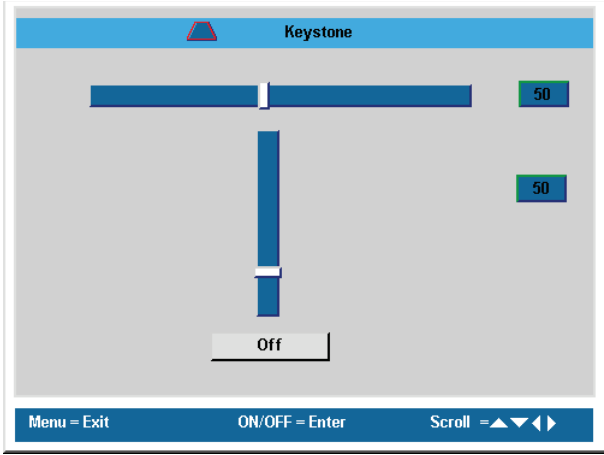
ITEM	DESCRIPTION	DEFAULT
Horizontal position	Press the cursor ◀ ▶ button to move the image left or right. (Range: 0 – 100)	50
Vertical position	Press the cursor ◀ ▶ button to move the image up or down. (Range: 0 – 100)	50
Keystone	<p>Press the cursor ◀ ▶ button to enter the Keystone screen. Press cursor ◀ ▶ button to correct the left and right distortion of the projected image. Press cursor ▲ ▼ button to up and down distortion of the image. Press the Enter button to enable and disable Keystone correction. (Range: -50 – +50)</p> 	0
Aspect ratio	Press the cursor ◀ ▶ button to toggle between the 4:3 standard format, Letter Box, Native, and the 16:9 High Definition TV (HDTV) format..	16:9

ITEM	DESCRIPTION	DEFAULT
White peaking	White Peaking increases the output in the brightest whites without changing the blacks and dark grays. It crushes the whites slightly, but it does not appear to clip them or seriously obscure white detail. If you prefer a stronger image, adjust toward the maximum setting. For a smoother, more natural image, adjust toward the minimum setting. Press the cursor ◀ ▶ button to adjust the white peaking. (Range: 0 – 100)	0
Logo display	Press ◀ ▶ to enable or disable if the logo displays when the projector starts, and when no source is detected. (Options: ON – OFF)	ON
Video overscan	Press the cursor ◀ ▶ button to set Video Overscan. (Options: Crop, Zoom, OFF)	OFF

Setup Menu Functions Available for Connected Source





FUNCTION	RGB	DVI	HDMI	COMPONENT VIDEO	COMPOSITE VIDEO	S-VIDEO	SCART
Brightness	x	x	x	x	x	x	x
Contrast	x	x	x	x	x	x	x
Sharpness	x	x	x	x	x	x	x
Color Temp	x	x	x	x	x	x	x
Color Saturation				x	x	x	
Color Tint				x	x	x	
Gamma	x	x	x	x	x	x	x
Color Space	x	x	x	x			
Video Standard					x	x	

x = available to video source

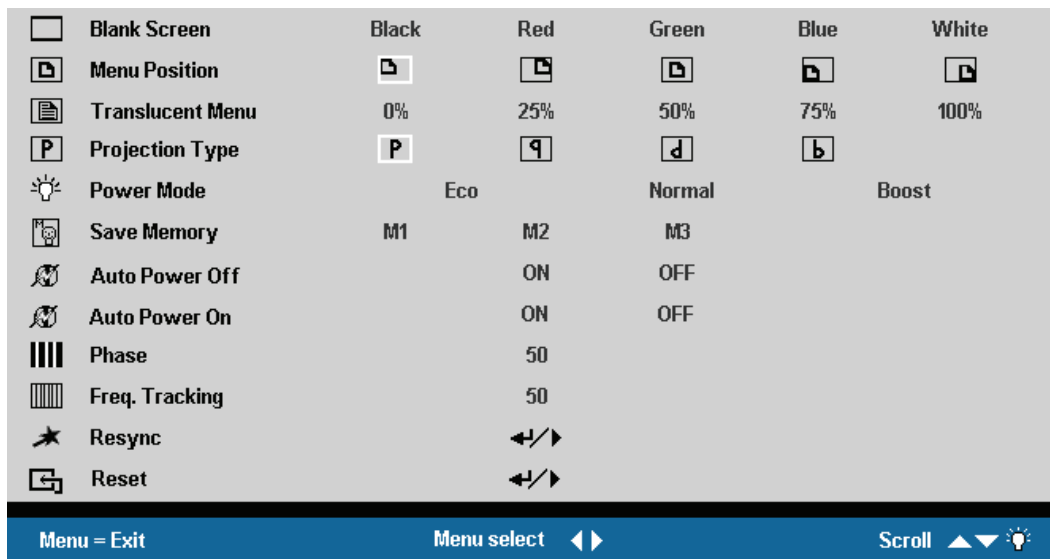
Advanced Menu

Press the **Menu** button to open the **OSD** menu. Press the cursor ◀ ▶ button to move to the **Advanced** menu. Press the cursor ▲ ▼ button to move up and down in the **Config** menu. Press ◀ ▶ to change values for settings, and then press **Enter** to confirm the new setting.



ITEM	DESCRIPTION	DEFAULT
Blank screen	Press the cursor ◀ ▶ button to select a background color for the blank screen. (Options: Black – Red – Green – Blue – White)	Black
Menu position	Press the cursor ◀ ▶ button to position the OSD on screen. (Options: Left, Right, Center, Down, Up)	Left top
Translucent menu	Press the cursor ◀ ▶ button to set menu screen translucency. (Options: 0, 25, 50, 75, 100%)	50%
Projection type	Press the cursor ◀ ▶ button to choose from four projection methods:  Desktop mount, front of screen  Desktop mount, rear of screen  Ceiling mount, front of screen  Ceiling mount, rear of screen	Desktop front 
Power mode	Press the cursor button to set power mode options. (Options: Eco (economy), Normal, Boost (bright)) Eco mode uses less power and extends lamp life, but decreases lamp brightness.	Eco
Save memory	Saves the current configuration to memory. Three memory spaces are provided: M1, M2, M3.	—
Auto power off	Press the cursor button to enable or disable automatic shut-down of lamp after 10 minutes of inactivity. (Options: ON – OFF)	OFF
Auto power on	Press the cursor button to enable or disable automatic start-up of lamp. (Options: ON – OFF)	OFF
Phase	Press the cursor ◀ ▶ button to adjust the A/D sampling clock. (Range: 0 - 180)	50

ITEM	DESCRIPTION	DEFAULT
Freq. tracking	Press the cursor ◀ ▶ button to adjust the A/D sampling number. (Range: 0 - 180)	50
Resync	Press the cursor ◀ ▶ button to determine the time-out delay of the OSD (Range: 10 – 20 sec.).	15
Reset	Resets Video Type, Video AGC, Projection, and Digital Zoom to default values	—



The Config menu functions are available to all video sources.

Language Menu

Press the **Menu** button to open the **OSD** menu. Press the cursor ◀ ▶ button to move to the **Language** menu. Press the cursor ▲ ▼ button to move up and down in the **Language** menu. Select the value, and then press **Enter** to confirm the new setting.

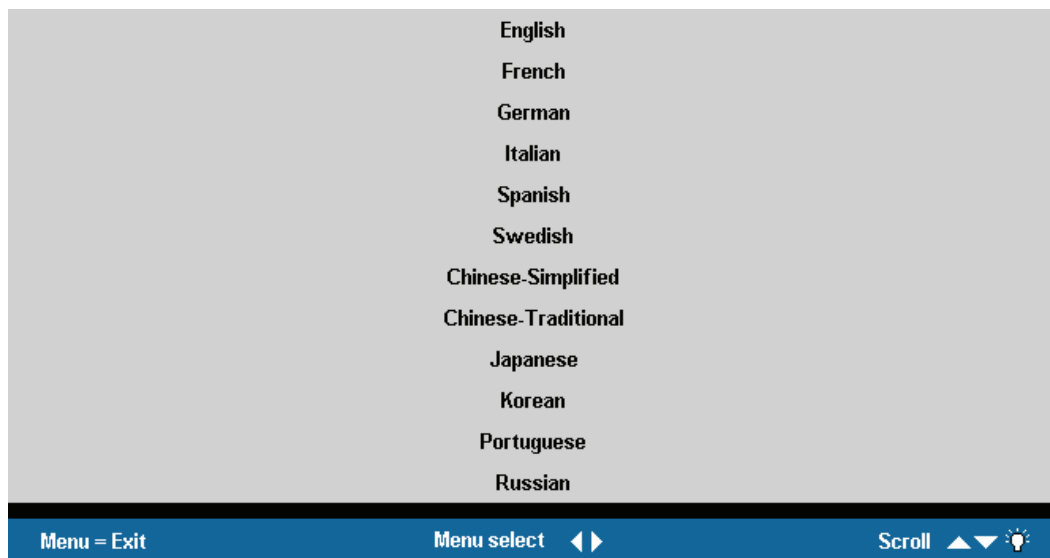

ITEM	DESCRIPTION	DEFAULT
Language	Press the cursor ◀ ▶ to select the desired language. Language options: English, French, German, Italian, Spanish, Swedish, Chinese-Simplified, Chinese-Traditional, Japanese, Korean, Portuguese, Russian	English



The Language menu functions are available to all video sources.

User Color Menu

Press the **Menu** button to open the **OSD menu**. Press the cursor ◀ ▶ button to move to the **Tool** menu. Press the cursor ▲ ▼ button to move up and down in the **Tool** menu. Press **Enter** to confirm the new setting.

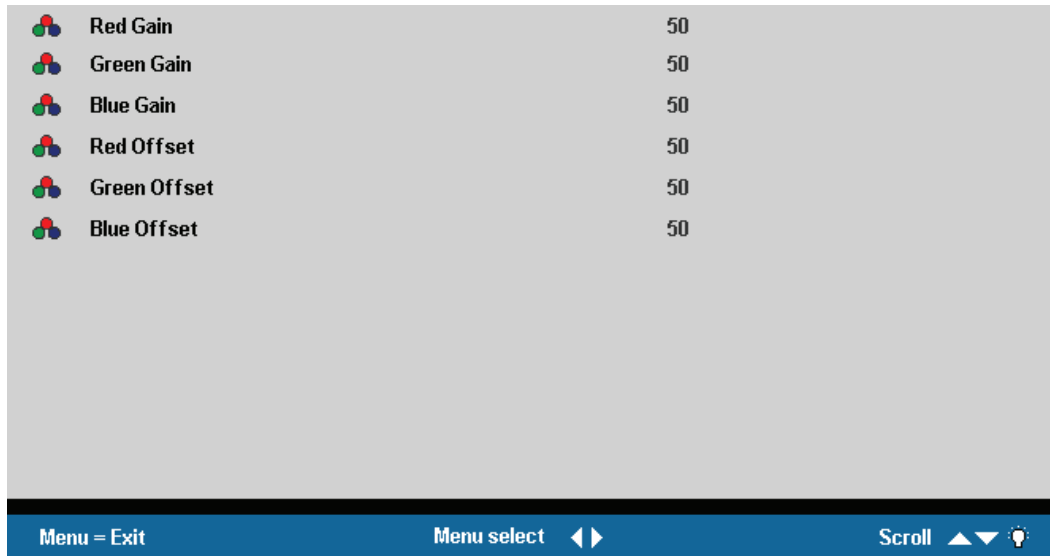

ITEM	DESCRIPTION	DEFAULT
Red gain	Press the cursor ◀ ▶ button to adjust the red color level. (Range: 0 - 100)	50
Green gain	Press the cursor ◀ ▶ button to adjust the green color level. (Range: 0 - 100)	50
Blue gain	Press the cursor ◀ ▶ button to adjust the blue color level. (Range: 0 - 100)	50
Red offset	Press the cursor ◀ ▶ button to adjust the red offset level. (Range: 0 - 100)	50
Green offset	Press the cursor ◀ ▶ button to adjust the green offset level. (Range: 0 - 100)	50
Blue offset	Press the cursor ◀ ▶ button to adjust the blue offset level. (Range: 0 - 100)	50

Service Menu

Press the **Menu** button to open the **OSD menu**. Press the cursor ◀ ▶ button to move to the **Service** menu. Press the cursor ▲ ▼ button to move up and down in the **Service** menu.

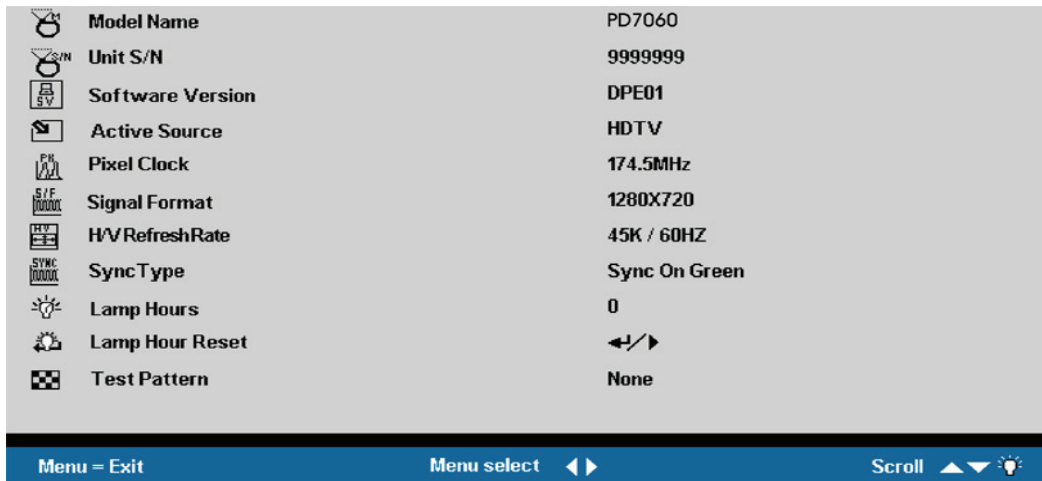

ITEM	DESCRIPTION	DEFAULT
Model name	Displays the model name of the device (PD4010, PD7010 or PD7060)	These items are display only.
Unit S/N	Displays the serial number of the device.	
Software version	Displays information about the software version.	
Active source	Displays the active source.	
Pixel clock	Displays information about the sampling rate.	
Signal format	Displays information about the type of signal format.	
H/V refresh rate	Displays the refresh horizontal and vertical refresh rates.	
Sync type	Displays information about the sync type signal.	
Lamp hours	Shows the number of hours lamp has been in use for Eco and Normal modes.	
Lamp hour Reset	After replacing the lamp, this item should be reset. Refer to “Replacing the Projection Lamp” on page 31.	
Test pattern	Displays information about the type of test pattern (Range: None, Solid, Checkerboard, Vertical Ramp, Horizontal Ramp, Grid, Horizontal Lines, Vertical Lines, Diagonal Lines, Splash Screen).	None

MAINTENANCE AND SECURITY

Replacing the Projection Lamp

Planar recommends changing the projection lamp after a warning message displays **Warning: Lamp life time Over**. It should only be replaced with a certified replacement part, which you can order from your local dealer.

Warning: Lamp life time Over

**Please contact your local dealer
for replacing lamp**

Important!

1. *The lamp contains a certain amount of mercury and should be disposed of according to local ordinance regulations.*
2. *Avoid touching the glass surface of the new lamp: Doing so may shorten its operation life.*

WARNING

Be sure to turn off and unplug the projector at least an hour before replacing the lamp. Failure to do so could result in a severe burn.

1. Loosen the screw on the lamp compartment cover.

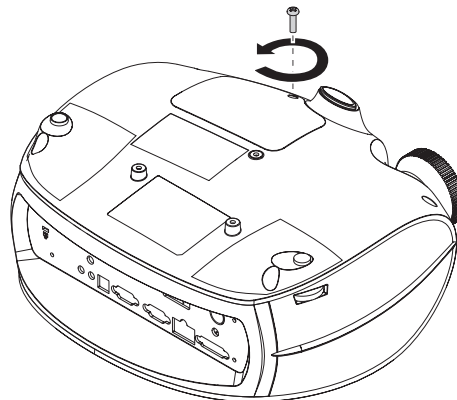

2. Open the lamp compartment cover.

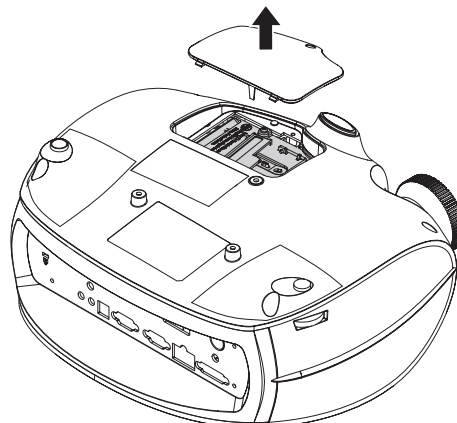

3. Remove the three screws from the lamp module.

4. Lift the module handle up.

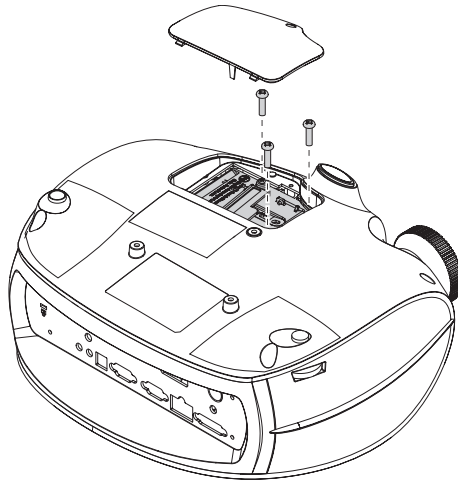

5. Pull firmly on the module handle to remove the lamp module.

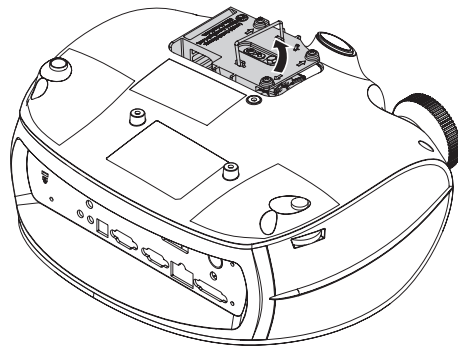

6. Reverse steps 1 to 5 to install the new lamp module.

Resetting the Lamp

After replacing the lamp, you should reset the lamp hour counter to zero. Refer to the following:

1. Press the Menu button to open the OSD menu.
2. Press the cursor ◀ ▶ button to move to the Service menu.
3. Press the cursor ▲ ▼ button to move down to Lamp Hour Reset.
4. Press the cursor ◀ ▶ or Enter button. A message screen appears.
5. Press the cursor buttons in this order: ▼ ▲ ◀ ▶.
The Status menu appears again showing the Lamp Hours reset to zero.

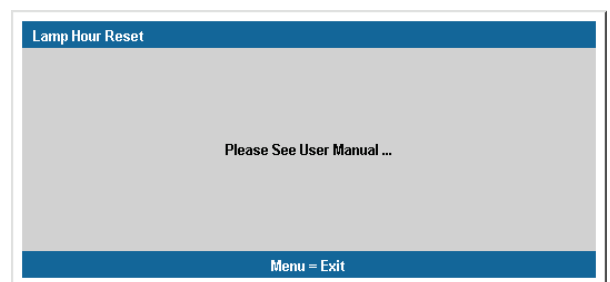

Cleaning the Projector

Cleaning the projector to remove dust and grime will help ensure trouble-free operation.



WARNING

1. *Be sure to turn off and unplug the projector at least an hour before cleaning. Failure to do so could result in a severe burn.*
2. *Use only a dampened cloth when cleaning. Do not allow water to enter the ventilation openings on the projector.*
3. *If a little water gets into the projector interior while cleaning, leave unplugged in a well-ventilated room for several hours before using.*
4. *If a lot of water gets into the projector interior when cleaning, have the projector serviced.*

Cleaning the Lens

You can purchase optic lens cleaner from most camera stores. Refer to the following to clean the projector lens.

1. Apply a little optic lens cleaner to a clean soft cloth.
(Do not apply the cleaner directly to the lens.)
2. Lightly wipe the lens in a circular motion.



1. *Do not use abrasive cleaners or solvents.*
2. *To prevent discoloration or fading, avoid getting cleaner on the projector case.*

Using the Kensington® Lock



If you are concerned about security, attach one end of a security cable to a permanent object and the other to the Kensington slot and a projector.



Contact your vendor for details on purchasing a suitable Kensington security cable. The security lock corresponds to Kensington's MicroSaver Security System. If you have any comment, contact: Kensington, 2853 Campus Drive, San Mateo, CA94403, U.S.A. Tel: 800-535-4242, <http://www.Kensington.com>.



TROUBLESHOOTING

These guidelines provide tips to deal with problems you may encounter while using the projector. If the problem remains unsolved, contact your dealer for assistance.

Often after time spent troubleshooting, the problem is traced to something as simple as a loose connection. Check the following before proceeding to the problem-specific solutions.

- Use some other electrical device to confirm that the electrical outlet is working.
- Ensure the projector is turned on.
- Ensure all connections are securely attached.
- Ensure the attached device is turned on.
- Ensure a connected PC is not in suspend mode.
- Ensure a connected notebook computer is configured for an external display. (This is usually done by pressing an Fn-key combination on the notebook.)

Tips for Troubleshooting

In each problem-specific section, try the steps in the order suggested. This may help you to solve the problem more quickly.

Try to pinpoint the problem and thus avoid replacing non-defective parts.

For example, if you replace batteries and the problem remains, put the original batteries back and go to the next step.

Keep a record of the steps you take when troubleshooting: The information may be useful when calling for technical support or for passing on to service personnel.

LED Error Messages

Before cooling, the LED will blink three (3) times in two (2) second intervals. The LED message is defined by the blinking sequence. A long blink is defined as 1 second. A short blink is defined as 0.3 seconds. The LED messages are listed below:

ERROR CODE MESSAGE	LED FLASH
Environment Over Temperature	1 long blink / 1 short blink
DMD Over Temperature	1 long blink / 2 short blinks
Lamp Over Temperature	1 long blink / 3 short blinks
Fan1 Locked	1 long blink / 4 short blinks
Fan2 Locked	2 long blinks / 2 short blinks
Fan3 Locked	2 long blinks / 3 short blinks
Fan4 Locked	2 long blinks / 4 short blinks
DMD Initial Fail	3 long blinks / 1 short blink
Lamp Initial Fail	3 long blinks / 2 short blinks
Ballast UART Error	3 long blinks / 3 short blinks
Temperature Sensor Fail	3 long blinks / 4 short blinks
Inter Lock Open	4 long blinks / 1 short blink

Common Problems and Solutions

This section describes some common problems and their solutions.

Image Problems

Problem: No image appears on the screen

1. Verify the settings on your notebook or desktop PC.
2. Turn off all equipment and power up again in the correct order.

Problem: The image is blurred

1. Adjust the **Focus** on the projector.
2. Press the **Auto** button on the remote control or projector.
3. Ensure the projector-to-screen distance is within the 7-meter (23-feet) specified range.
4. Check that the projector lens is clean.

Problem: The image is wider at the top or bottom (trapezoid effect)

1. Position the projector so it is as perpendicular to the screen as possible.
2. Use the **Keystone** button on the remote control or projector to correct the problem.

Problem: The image is reversed or upside down

Check the **Projection** setting on the **Utility** menu of the OSD.

Problem: The image is streaked

1. Set the **Frequency** and **Tracking** settings on the **Utility** menu of the OSD to the default settings.
2. To ensure the problem is not caused by a connected PC's video card, connect to another computer.

Problem: The image is flat with no contrast

Adjust the **Contrast** setting on the **Image** menu of the OSD.

Problem: The color of the projected image does not match the source image.

Adjust the **Color Temperature** and **Gamma** settings on the **Image** menu of the OSD.

Lamp Problems

Problem: There is no light from the projector

1. Check that the power cable is securely connected.
2. Ensure the power source is good by testing with another electrical device.
3. Restart the projector in the correct order and check that the Power LED is green.
4. If you have replaced the lamp recently, try resetting the lamp connections.
5. Replace the lamp module.
6. Put the old lamp back in the projector and have the projector serviced.

Problem: The lamp goes off

1. Power surges can cause the lamp to turn off. Press the power button twice to turn off the projector. When the Power LED is on, press the power button.
2. Replace the lamp module.
3. Put the old lamp back in the projector and have the projector serviced.

Remote Control Problems

Problem: The projector does not respond to the remote control

1. Direct the remote control towards remote sensor on the projector.
2. Ensure the path between remote and sensor is not obstructed.
3. Turn off any fluorescent lights in the room.
4. Check the battery polarity.
5. Replace the batteries.
6. Turn off other Infrared-enabled devices in the vicinity.
7. Have the remote control serviced.

SPECIFICATIONS

Hardware Specifications

MODEL	PD4010	PD7010	PD7060
Display type	TI DMD 0.55-inch x 1, 12 degrees, DDR DMD with DDP2000	TI DMD 0.65-inch x 1, 12 degrees, LVDS DMD with DDP3020	TI DMD 0.65-inch x 1, 12 degrees, LVDS DMD with DDP3020
Resolution	480p (854x480)	720p (1280x720)	720p (1280x720)
Color	16.7 Million (24-bits/pixel)		
Weight	4kg / 8.8lbs		
Projection distance	1.5 to 7 meters (59 to 275 inches)		
Projection screen size	0.76 to 3.81 meters (30 to 150 inches)	0.88 to 4.45 meters (35 to 175 inches)	0.88 to 4.45 meters (35 to 175 inches)
Projection lens	Manual zoom; manual focus		
Zoom ratio	1.16:1		
Horizontal keystone correction	N/A	+/- 40 degrees	+/- 40 degrees
Vertical keystone correction	+/- 15 degrees		
Projection methods	Desktop front/rear; ceiling front/rear		
Data compatibility	IBM PC or compatibles (VGA, SVGA, XGA), Mac	IBM PC or compatibles (VGA, SVGA, XGA, SXGA), Mac	IBM PC or compatibles (VGA, SVGA, XGA, SXGA), Mac
SDTV/EDTV/HDTV	480i, 576i/480p, 576p/720p, 1080i	480i, 576i/480p, 576p/720p, 1080i, 1080p	480i, 576i/480p, 576p/720p, 1080i, 1080p
Video compatibility	NTSC/NTSC 4.43, PAL (B/G/H/I/M/N 60), SECAM		
H-Sync	15,31 - 70 kHz	15,31 - 90 kHz	15,31 - 90 kHz
V-Sync	50 - 85 Hz	50 - 85 Hz	50 - 85 Hz
Safety certification	FCC-B, UL, c-UL, TUV-GS, CB, CE, CCC, ICES-003 (class B), C-Tick, NOM, WEEE, RoHS, PCT, MIC/EK		
Operation temperature	10° C ~ 35° C		
Dimensions	See "Projector Dimensions" on page 44		
Power consumption	Typical 255W (normal mode); Typical 230W (Eco mode)		
Stand By	< 1 watt		
Lamp	Boost mode: 230W; normal mode: 200W; Eco mode: 180W		

Input/output Connectors

MODEL	PD4010	PD7010	PD7060
PC	RGB	RGB	RGB /DVI-D
Video	Composite video (RCAx1)		
	Mini-jack to S-Video (Mini-DIN)		
	Component (RCA x3)		
	DVI-D (HDCP)		
	None	HDMI (HDCP)	HDMI (HDCP)
Security	Kensington slot		

PD4010 Projection distance and size table

Projection Distance	MAX. SCREEN SIZE (WIDE)		1.8:1	MAX. SCREEN SIZE (TELE)		2.1:1
	Diagonal	Width	Height	Diagonal	Width	Height
1.50	0.95	0.83	0.47	0.83	0.72	0.41
2.40	1.52	1.33	0.75	1.32	1.15	0.65
2.80	1.77	1.55	0.87	1.54	1.34	0.76
3.20	2.03	1.77	0.99	1.76	1.54	0.86
3.60	2.28	1.99	1.12	1.98	1.73	0.97
4.00	2.54	2.21	1.24	2.20	1.92	1.08
4.40	2.79	2.43	1.37	2.42	2.11	1.19
4.80	3.04	2.65	1.49	2.65	2.31	1.30
5.20	3.30	2.87	1.62	2.87	2.50	1.40
5.60	3.55	3.09	1.74	3.09	2.69	1.51
7.00	4.44	3.87	2.18	3.86	3.36	1.89

**Units of measurements: meters*

Projection Distance	MAX. SCREEN SIZE (WIDE)		1.8:1	MAX. SCREEN SIZE (TELE)		2.1:1
	Diagonal	Width	Height	Diagonal	Width	Height
59.06	37.43	32.63	18.35	32.54	28.36	15.96
94.49	59.90	52.20	29.36	52.07	45.38	25.53
110.24	69.88	60.90	34.26	60.75	52.95	29.78
125.98	79.86	69.60	39.15	69.43	60.51	34.04
141.73	89.84	78.31	44.05	78.11	68.08	38.29
157.48	99.83	87.01	48.94	86.78	75.64	42.55
173.23	109.81	95.71	53.83	95.46	83.20	46.80
188.98	119.79	104.41	58.73	104.14	90.77	51.06
204.72	129.77	113.11	63.62	112.82	98.33	55.31
220.47	139.76	121.81	68.52	121.50	105.89	59.57
275.59	174.70	152.26	85.65	151.84	132.37	74.46

**Units of measurements: inches*

PD7010. PD7060 Projection distance and size table

Projection Distance	MAX. SCREEN SIZE (WIDE)		1.8:1	MAX. SCREEN SIZE (TELE)		2.1:1
	Diagonal	Width	Height	Diagonal	Width	Height
1.50	1.12	0.98	0.55	0.98	0.85	0.48
2.40	1.80	1.57	0.88	1.56	1.36	0.77
2.80	2.10	1.83	1.03	1.83	1.59	0.89
3.20	2.40	2.09	1.18	2.09	1.82	1.02
3.60	2.70	2.35	1.32	2.35	2.05	1.15
4.00	3.00	2.61	1.47	2.61	2.27	1.28
4.40	3.30	2.88	1.62	2.87	2.50	1.41
4.80	3.60	3.14	1.76	3.13	2.73	1.53
5.20	3.90	3.40	1.91	3.39	2.95	1.66
5.60	4.20	3.66	2.06	3.65	3.18	1.79
7.00	5.25	4.58	2.57	4.56	3.98	2.24

**Units of measurements: meters*

Projection Distance	MAX. SCREEN SIZE (WIDE)		1.8:1	MAX. SCREEN SIZE (TELE)		2.1:1
	Diagonal	Width	Height	Diagonal	Width	Height
59.06	44.29	38.60	21.71	38.50	33.55	18.87
94.49	70.86	61.76	34.74	61.60	53.69	30.20
110.24	82.67	72.05	40.53	71.86	62.63	35.23
125.98	94.48	82.34	46.32	82.13	71.58	40.26
141.73	106.29	92.64	52.11	92.40	80.53	45.30
157.48	118.09	102.93	57.90	102.66	89.48	50.33
173.23	129.90	113.22	63.69	112.93	98.43	55.36
188.98	141.71	123.51	69.48	123.19	107.37	60.40
204.72	153.52	133.81	75.27	133.46	116.32	65.43
220.47	165.33	144.10	81.06	143.73	125.27	70.46
275.59	206.67	180.12	101.32	179.66	156.59	88.08

**Units of measurements: inches*

TIMING MODE TABLE

The projector can display several resolutions. The following table outlines the resolutions that can be displayed by the projector.

SIGNAL	RESOLUTION	FREQ. V	FREQ. H	VIDEO	S-VIDEO	SCART	COMPONENT	RGB	DVI-D	HDMI
VESA	640x480	59.94	31.47	—	—	—	—	○	○	○
	640x480	72.81	37.86	—	—	—	—	○	○	○
	640x480	74.99	37.49	—	—	—	—	○	○	○
	640x480	85	43.27	—	—	—	—	○	○	○
	800x600	56.25	35.15	—	—	—	—	○	○	○
	800x600	60.32	37.88	—	—	—	—	○	○	○
	800x600	72.19	48.08	—	—	—	—	○	○	○
	800x600	75	46.87	—	—	—	—	○	○	○
	800x600	85.06	53.67	—	—	—	—	○	○	○
	1024x768	60	48.36	—	—	—	—	○	○	○
	1024x768	70.07	56.47	—	—	—	—	○	○	○
	1024x768	75.03	60.02	—	—	—	—	○	○	○
	1024x768	85.03	68.28	—	—	—	—	○	○	○
	1280x1024	60.02	63.98	—	—	—	—	○	○	○
Apple Macintosh	640x480	66.59	34.99	—	—	—	—	○	○	○
	832x624	74.54	49.72	—	—	—	—	○	○	○
NTSC	NTSC-J	59.94	15.73	○	○	○	○	—	—	—
PAL/SECAM	PAL, SECAM	50	15.63	○	○	○	○	—	—	—
SDTV	480I	59.94	15.73	—	—	—	○	—	—	—
	576I	50	15.63	—	—	—	○	—	—	—
	480P	59.94	31.47	—	—	—	○	—	—	○
	576P	50	31.25	—	—	—	○	—	—	○
HDTV	1035I	60	33.75	—	—	—	○	—	—	○
	1080I	50	28.12	—	—	—	○	—	—	○
	1080I	60	33.75	—	—	—	○	—	—	○
	720P	50	37.5	—	—	—	○	—	—	○
	720P	60	45	—	—	—	○	—	—	○
	1080P	60	67.5	—	—	—	○	—	—	○

○ : Frequency supported

— : Frequency not supported

The native resolution for the PD7010 and PD7060 is 1280 x 720. The native resolution for the PD4010 is 854 x 480. Resolution other than native mode may be displayed with uneven size of text or lines.

Projector Dimensions

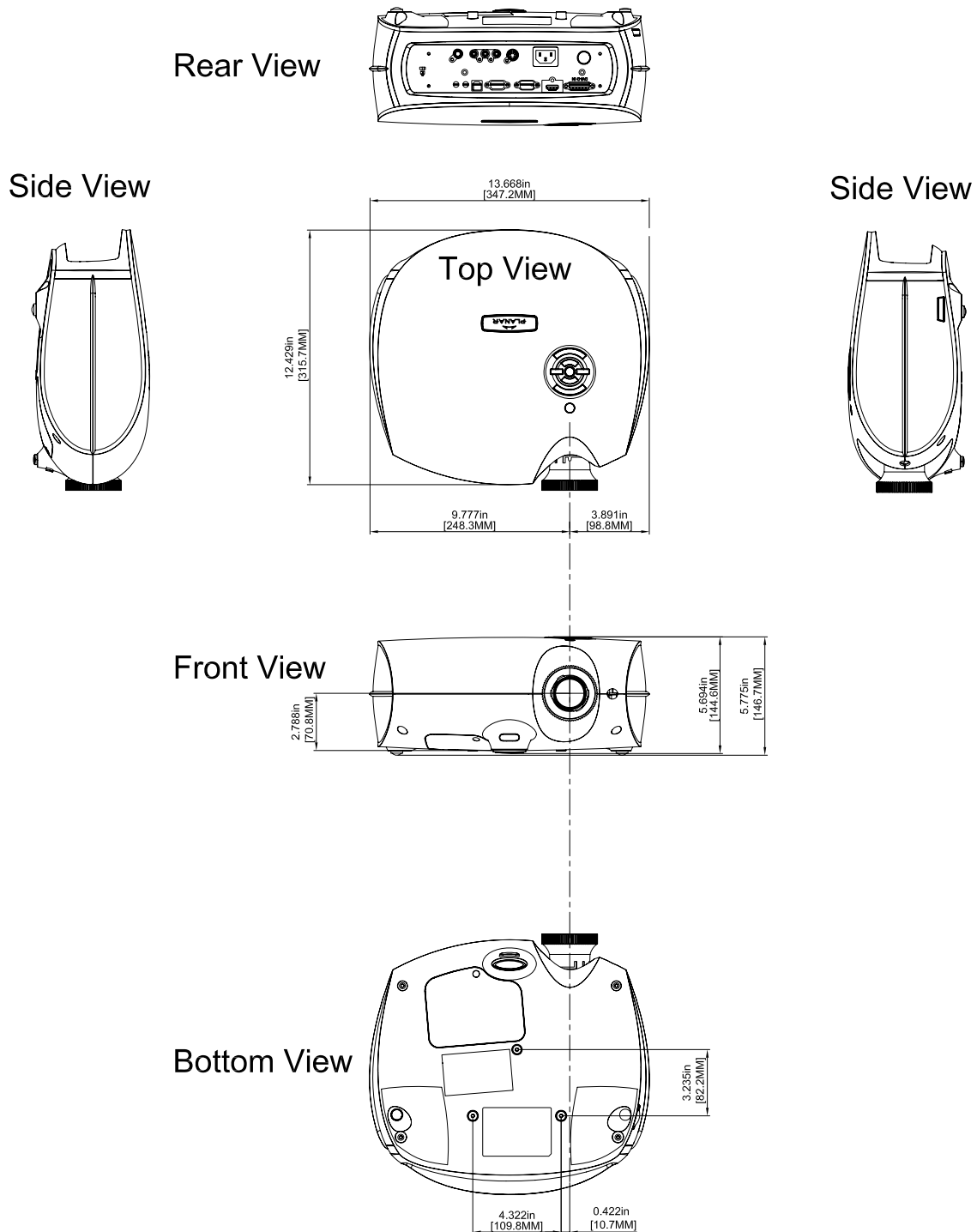

Units of measurement: inches and mm



For ceiling installations, use approved mounting hardware and M4 screws with a maximum screw depth of 10 mm (0.39 inch).



REGULATORY COMPLIANCE

FCC Warning

This equipment has been tested and found to comply with the limits for a Class B digital device pursuant to Part 15 of the FCC Rules. These limits are designed to provide reasonable protection against harmful interference when the equipment is operated in a commercial environment.

This equipment generates, uses, and can radiate radio frequency energy and, if not installed and used in accordance with the instruction manual, may cause harmful interference to radio communications. Operation of this equipment in a residential area is likely to cause harmful interference in which case the user will be required to correct the interference at his own expense.

Changes or modifications not expressly approved by the parties responsible for compliance could void the user's authority to operate the equipment.

Canada

This class B digital apparatus complies with Canadian ICES-003.

Safety Certifications

FCC Class B, UL, c-UL, CE, TUV-GS, CCC, PCT, MIC/EK

EN 55022 Warning

This is a Class B product. In a domestic environment, it may cause radio interference, in which case the user may be required to take adequate measures. The typical use is in a conference room, meeting room, or auditorium.

Planar Systems, Inc.

Corporate Headquarters
1195 NW Compton Drive
Beaverton, OR 97006-1992

Planar Customer Support

Telephone:

US: 1-866-PLANAR1 (866) 752-6271

Outside US: (503) 748-5799

E-mail: PlanarSupport@planar.com

Online Technical Library: <http://www.planar.com/support>

Hours: M-F, 8am - 8pm ET, 12pm - 12am GMT

©2006 Planar Systems, Inc. Planar is a registered trademark of Planar System, Inc.

Other brands and names are the property of their respective owners.

Technical Information in this document is subject to change without notice.